

œuf





ABOUT OEUF

Michael Ryan and Sophie Demenge are the husband-and-wife team who created Oeuf. Born and raised in upstate New York, Ryan brings an engineer's perspective and eye for minimalist design to the company's high-quality, functional pieces. Raised in Paris, Sophie's playful and practical approach to design was nurtured in such diverse places as the philosophy department at the Sorbonne, trapeze classes in San Francisco, the Pratt Institute in New York.

After meeting, the pair teamed up to hone their aesthetic in R+D Designs, a home goods company known for ingenious pieces. The birth of their first child in 2002 turned the couple's talents to children's design, and together they created Oeuf with the vision to provide modern parents with high-quality, streamlined pieces that are sustainably sourced and responsibly created. The company started with just one crib, and has grown to produce several lines of stylish nursery and junior furniture, kids' clothing, fun toys and elegant yet whimsical décor objects, sold all over the world. Michael and Sophie live in Brooklyn with their two children, who are their main source of inspiration for creating new products. Being parents gives them great insight into what kids will love using and what parents want, allowing for kid-friendly furniture and décor to blend in a modern stylish house. Their family values reinforce their commitment to ethical business practices – leading to the company motto, "Be Good."

Oeuf's commitment to combining intuitive design, ecological and sustainable production with simple & clean style has made it one of the most respected and independent brands in the market.

MANIFESTO

When we were kids, whenever our parents dropped us off somewhere like school, our grandparents' house for the weekend or even summer camp, they always gave us a hug and a kiss and told us to "be good!" as they waved goodbye.

As kids we were very literal and knew this meant...don't cut your sister's hair, don't glue yourself to the wall, don't go running off into the woods with nothing but your underwear and a toothbrush. At the time, it was mostly about good behavior.

Now as parents, we realize there is a whole other level of meaning when we kiss them goodbye and tell them to be good. We know we're really telling them to be good people. Do the right thing. Make us proud. Be the kind of people we hope to be. As Oeuf, we have the chance to elevate this notion once again and be a good company. When we say Be Good, we mean...

Be good designers.

Simple, clean, intuitive products that are easy and safe to use; made with quality craftsmanship that will last from generation to generation; designed with a European sensibility that is fun and stylish, reflecting the needs and lifestyle of today's families.

Be good people.

Respect the people who work with us and treat them fairly whether employees, artisans, retailers or consumers. Provide a safe and supportive working environment that allows working families to live and thrive in the United States, Europe and abroad. Honor cultural traditions, diversity and local values. Pay people living wages that enable them to live healthy and fulfilling lives and send their own children to school.

Be good to the planet.

Use natural, renewable, recyclable materials that emphasize conservation and lead to environmentally sound products. Employ eco-conscious manufacturing processes that promote sustainability.

Be Good is not just something we say, it's something we mean. As parents, we want our children to inherit a world that is better than we found it. As Oeuf, we have the ability to make that happen.

Oeuf

MADE IN EUROPE

As part of Oeuf's mission to "be good," we make sure all our products are environmentally sound – from our choice of materials, to the manufacturing processes, to the recycled packaging our products come in.

All Oeuf's furniture is made of sustainable, premium materials and is ethically produced in the small European country of Latvia. Forests are abundant, fast-growing, and cover over 70% of Latvia, which has a proud tradition of woodworking. As a respected member of the European Union, Latvia also has strong standards and regulations relating to labor, safety, quality, and the environment.

All Oeuf's furniture is produced in a Forest Stewardship Certified facility, with state of the art dust collection to protect workers and the environment. All waste possible is recycled through licensed facilities, and wood waste is reprocessed at the factory into briquettes, which are then used to heat the factory during Latvia's snowy winters. In addition, our engineered eco-MDF panels are made from recovered wood fibers.

To protect our children and workers alike, we only use non-toxic, water-based finishes on all of our products, and all of our materials (solid wood, Baltic birch plywood and eco-MDF) meet the stringent European E1 and Californian CARB 2 emissions standards.



1



2



3



4

- 1. Logs at the mill for processing
- 2. View of Latvia
- 3, 4. Our factory uses the latest technology in panel processing surface preparation and finishing

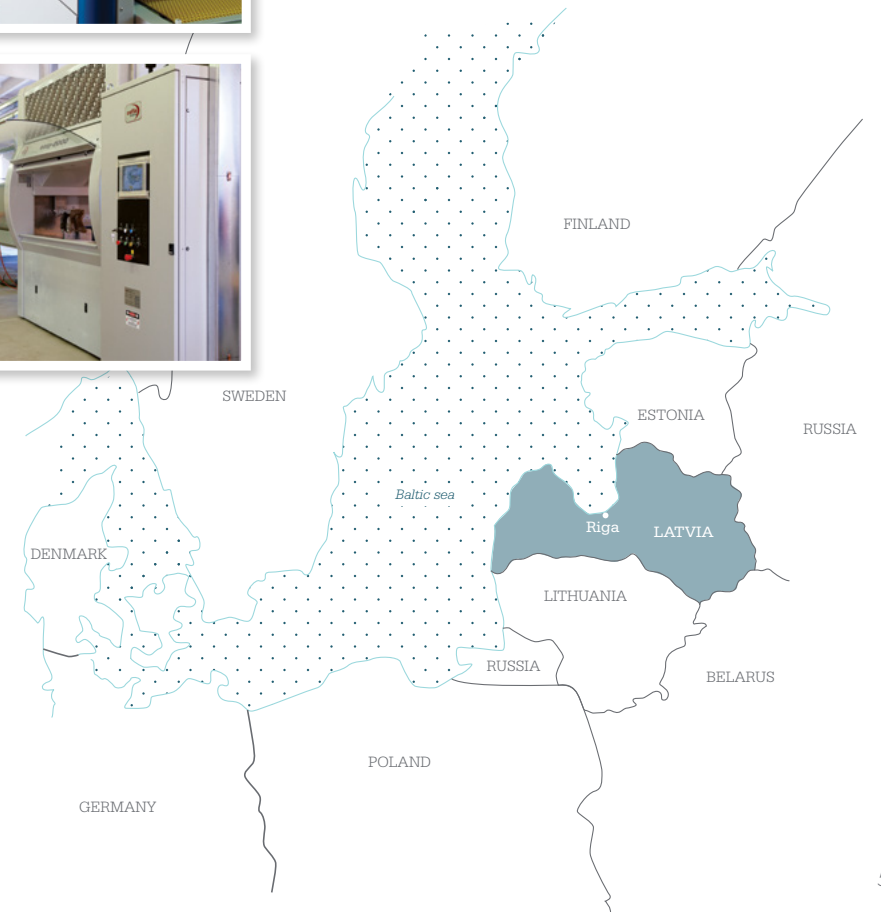

CLASSIC COLLECTION

Clean and contemporary, this collection leads the way in smart, modern design

Safe & Eco-friendly

- finishes are non-toxic, water-based and free of VOC health hazards
- crib and toddler bed are made of solid birch and eco-MDF
- dresser is made of Baltic birch plywood with eco-MDF drawer faces

Options & Functionality

- crib converts to a true 4-sided toddler bed with conversion kit (sold separately)
- crib has 3 adjustable mattress positions
- 3 drawer dresser can be used as a changer by attaching the changing tray or pad
- 6 drawer dresser can be used as a changer by attaching the XL station
- additional matching items include toy store, mini library and changing tray
- crib and dresser have adjustable legs for uneven surfaces
- dresser has metal knobs to coordinate with legs
- mattress size: 71 cm W × 132 cm L

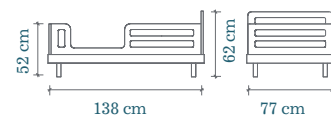
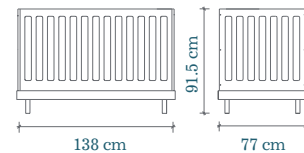

Crib



Toddler Bed



Merlin 3 drawer dresser with Classic base



Merlin 6 drawer dresser with Classic base



MAX'S NURSERY

Max got his Classic Crib when he was one month old. He loves to play hide and seek behind the bars, or relax inside with his buddies, Ray the rat and Silas the snake.



SPARROW COLLECTION

This multi-stage collection is elegant with a light and airy feel

Safe & Eco-friendly

- finishes are non-toxic, water-based and free of VOC health hazards
- crib is made of solid birch and Baltic birch plywood
- dresser is made of Baltic birch plywood with eco-MDF drawer faces

Options & Functionality

- crib converts to a toddler bed with conversion kit (sold separately)
- crib has 3 adjustable mattress positions
- 3 drawer dresser can be used as a changer by attaching the changing tray or pad
- 6 drawer dresser can be used as a changer by attaching the XL station
- 5 color options to coordinate with any décor
- additional matching items include toy store, mini library and changing tray
- mattress size: 71 cm W × 132 cm L

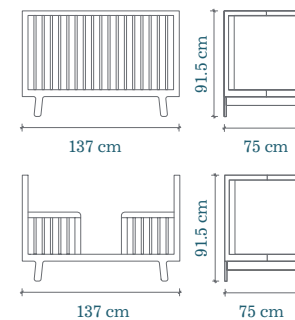

Crib



Toddler Bed Conversion



Merlin 3 drawer dresser with Sparrow base



Merlin 6 drawer dresser with Sparrow base

- birch
- white
- walnut
- slate
- petal



white/birch



white/walnut

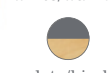

slate/birch

(only for Merlin 3 drawer dresser)



ROSA'S NURSERY

Rosa is a daredevil, always trying to climb out of her crib, like her friend the monkey. So her parents decided that for her upcoming second birthday, she will get the toddler bed conversion kit.





CHARLIE'S NURSERY

Little Charlie is a happy baby who sleeps in the Rhea crib... a lot! He shares his crib with a pigeon couple he rescued from the streets of Brooklyn, who he named Pablo and Penelope.

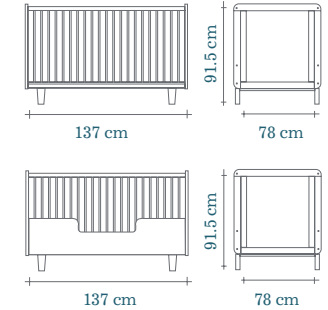

RHEA COLLECTION

The Rhea collection offers great value with uncompromising quality

Safe & Eco-friendly

- finishes are non-toxic, water-based and free of VOC health hazards
- crib is made of solid birch and Baltic birch plywood
- dresser is made of Baltic birch plywood with eco-MDF drawer faces

Options & Functionality

- crib converts to toddler bed with conversion kit (sold separately)
- crib has 3 adjustable mattress positions
- 3 drawer dresser can be used as a changer by attaching the changing tray or pad
- 6 drawer dresser can be used as a changer by attaching the XL station
- additional matching items include toy store, mini library and changing tray
- mattress size: 71 cm W × 132 cm L



Crib



Toddler Bed Conversion



Merlin 3 drawer dresser
with Rhea base



Merlin 6 drawer dresser
with Rhea base





LIZA'S NURSERY

Liza giggled when she first saw her room, when she was 3 months old. Her new crib was so sleek and playful, she knew instantly they would be best friends.

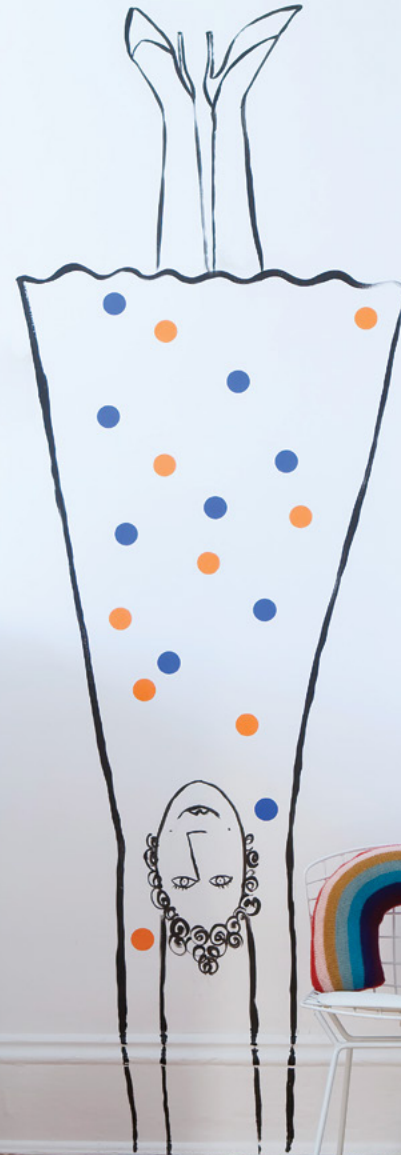

ELEPHANT CRIB

A fun addition to the nursery that you can assemble in 10 minutes

Safe & Eco-friendly

- sustainably produced in Europe in an FSC certified facility
- finishes are non-toxic, water-based and free of VOC health hazards
- crib is made of eco-MDF

Options & Functionality

- assembling the crib takes 10 minutes
- made from 4 interlocking panels with minimal use of hardware
- crib has 3 adjustable mattress positions
- crib converts to toddler bed with conversion kit (sold separately)
- additional matching items include toy store, and mini library
- mattress size: 71 cm W × 132 cm L

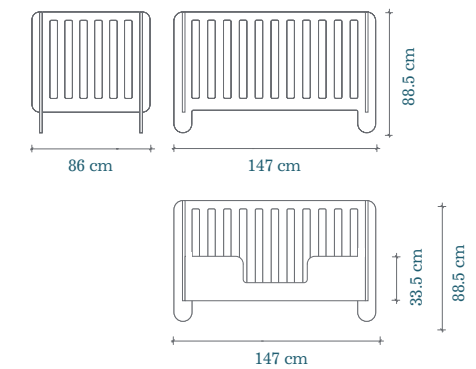

Crib



Toddler Bed



white

FAWN COLLECTION

A convertible design to last for years to come

Safe & Eco-friendly

- finishes are non-toxic, water-based and free of VOC health hazards
- bassinet and crib are made of Baltic birch plywood and eco-MDF
- dresser is made of Baltic birch plywood with eco-MDF drawer faces

Options & Functionality

- the Fawn System comes with all the necessary parts to assemble the bassinet and the crib (both cannot be assembled simultaneously)
- crib converts to toddler bed with conversion kit (sold separately)
- crib has 3 adjustable mattress positions
- 3 drawer dresser can be used as a changer by attaching the changing tray or pad
- 6 drawer dresser can be used as a changer by attaching the XL station
- additional matching items include toy store, mini library and changing tray
- mattress size: bassinet - 40.6 cm W × 71.1 cm W
crib & toddler bed - 71.1 cm W × 132.1 cm L (standard size crib mattress)
- bassinet mattress included

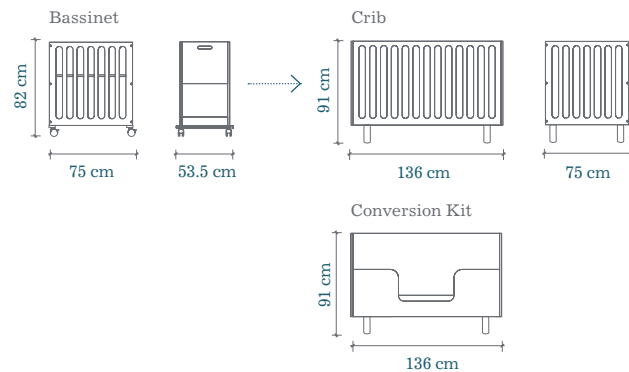

OTTO'S NURSERY

Otto has slept in the Fawn since he was born. Starting in the petite bassinet, he is now a playful toddler enjoying the converted, full sized crib.

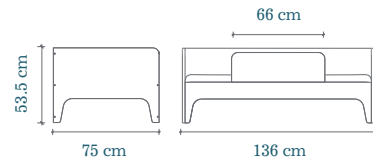

Toddler Bed with guard rail



PERCH TODDLER BED

Celebrate the important milestone of moving to a “big kid” bed with the Perch toddler bed

Safe & Eco-friendly

- sustainably produced in Europe in an FSC certified facility
- finishes are non-toxic, water-based and free of VOC health hazards
- made of Baltic birch plywood and Eco-MDF

Options & Functionality

- easy to assemble
- toddler bed converts to a day bed by removing security rail
- comfortable sleeping for your child to age 6
- additional matching items include Perch bunk bed, Merlin dressers and mini library
- standard crib mattress size: 71 cm W × 132 cm L



SIMON'S ROOM

Simon knows he's a big kid now, so he likes having a Perch toddler bed instead of a crib - especially since it's so much easier to get out to play with his cars!





MERLIN DRESSER

Designed to match all Oeuf collections

Safe & Eco-friendly

- anti-tipping hardware included
- finishes are non-toxic, and free of VOC health hazards
- dresser is made of Baltic birch plywood with eco-MDF drawer faces

Options & Functionality

- 3 drawer dresser can be used as a changer by attaching the changing tray or pad

- 6 drawer dresser can be used as a changer by attaching the XL station
- drawers have a 50 lbs. weight capacity
- concealed undermount roller bearing drawer slides, with soft closing and stay-close features
- coordinates with all Oeuf collections by changing its legs
- dresser with classic base has adjustable legs for uneven surfaces
- dressers have coordinating knobs and legs
- minimal assembly required
- changing pad is sold separately

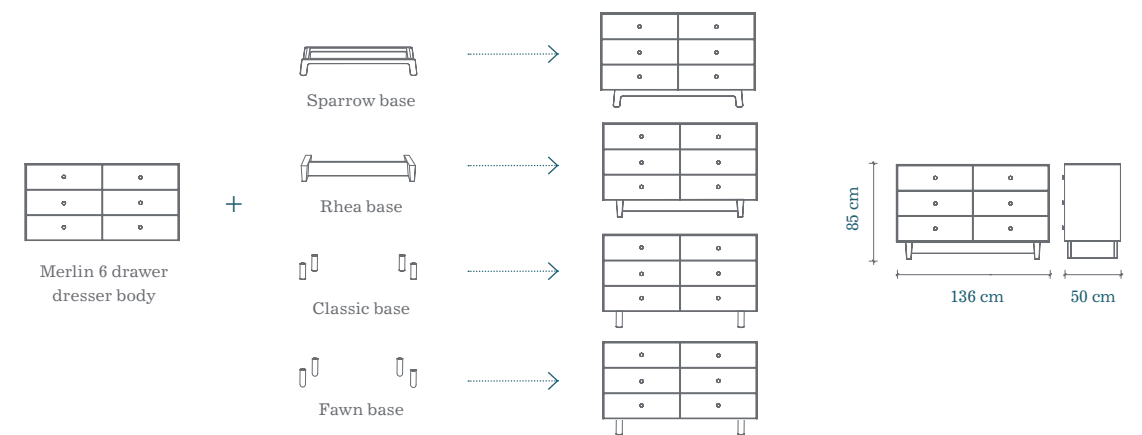
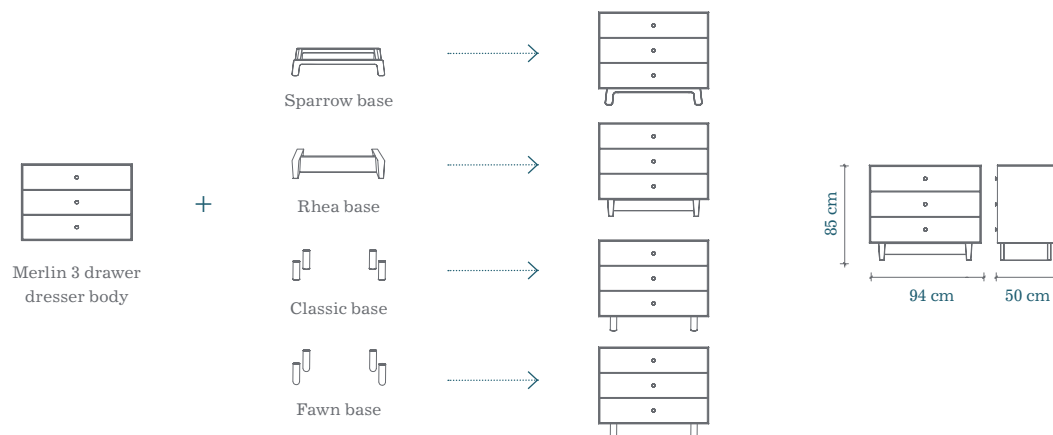



CHANGING TRAY & XL STATION/WALL SHELVES

Practical and versatile, these changing trays can turn your dresser into a changing table, which is perfect for smaller spaces

Safe & Eco-friendly

- finishes are non-toxic, water-based and free of VOC health hazards
- made of solid birch and Baltic birch plywood

Options & Functionality

Changing tray:

- attaches safely to the Merlin 3 drawer dresser
- changing pad included (40.6 cm W × 82.6 cm L × 10.2 cm H)

XL Station:

- attaches safely to Merlin 6 drawer dressers
- converts to wall-mounted shelving unit
- adjustable compartments for convenient storage
- changing pad sold separately

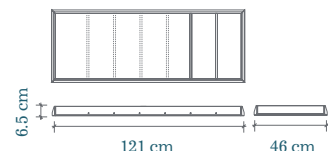
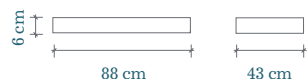

Changing tray on
Merlin 3 drawer dresser



XL Station on
Merlin 6 drawer dresser

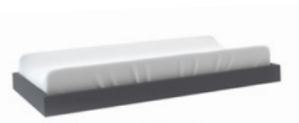

Changing tray
white slate



XL Station
white

TOY STORE

Easy to reach and easy to see into, open boxes make it easy for a child to find (and put away!) toys

Safe & Eco-friendly

- sustainably produced in Europe in an FSC certified facility
- finishes are non-toxic, water-based and free of VOC health hazards
- made of Baltic birch plywood and eco-MDF

Options & Functionality

Toy Store:

- bins can be angled or flat
- dividers can be removed
- low overall height for easy access
- coordinates with all Oeuf collections

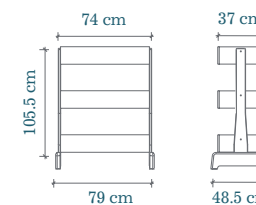

LIBRARIES & ML NIGHT STAND

No matter what size & style you choose, a mix of open and closed storage lets you display what you love and hide small messes

Safe & Eco-friendly

- sustainably produced in Europe in an FSC certified facility
- finishes are non-toxic, water-based and free of VOC health hazards
- made of Baltic birch plywood and eco-MDF

Options & Functionality

Mini Library:

- open and closed storage
- easy to reach height for the little ones

- narrow foot print makes it great for small spaces

Vertical Mini Library:

- strong and stable construction
- two storage compartments with hinged doors
- can be attached to wall

ML Night Stand:

- ideal place for bedside lamp and books
- storage compartment with hinged door
- coordinates with all Oeuf collections

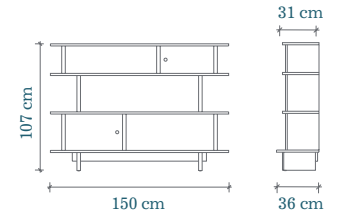

Mini Library

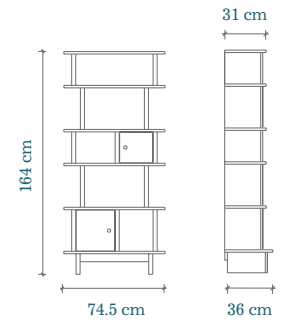

Vertical Mini Library

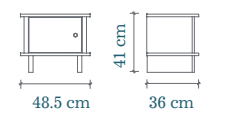

white/birch

white/walnut



ML Night Stand



Chairs shown with Oeuf reusable stickers applied (sold separately)

PLAY TABLE & CHAIRS

Adding a spirit of whimsy to the home

Safe & Eco-friendly

- finishes are non-toxic, water-based and free of VOC health hazards
- chairs are made of bent Baltic birch plywood, table made of Baltic birch plywood and scratch resistant high pressure laminate

Options & Functionality

- easy to assemble
- chairs have low seat for children from age 2 to 6 (sold as a set of 2)
- easy-to-clean laminate tabletop

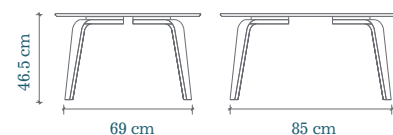
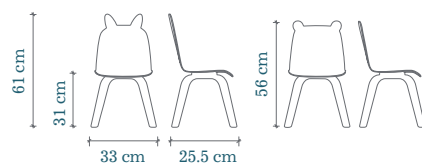

DANTE'S PLAY ROOM

Dante is an artist who has never been one to color inside the lines. The play table and whimsical animal chairs feed right into his imaginative mind, creating the perfect work space...or a good spot to just have a snack!





BROOKLYN DESK

An urban take on workspace

Safe & Eco-friendly

- finishes are non-toxic, water-based and free of VOC health hazards
- birch plywood and scratch resistant high pressure laminate

Options & Functionality

- easy to assemble
- 3 adjustable desk heights (62.2 cm, 68.6 cm, 74.9 cm)
- 3 removable boxes
- solid and stable construction
- easy-to-clean laminate tabletop

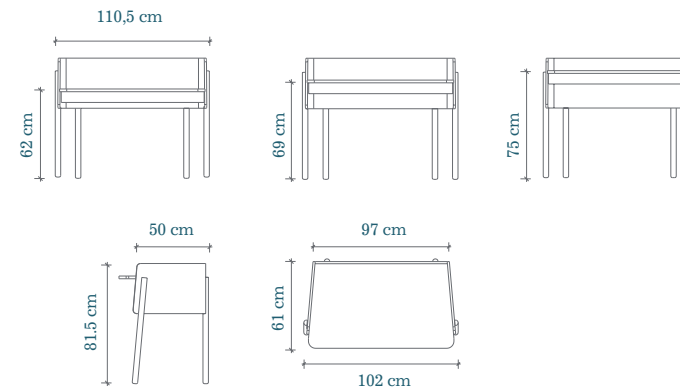

SKY'S BEDROOM

Sky is a creative genius 24/7/365 and a serious scholar the night before her homework's due. All the magic happens at her majorly stylish desk, which grows with her from her crayon days to her laptop years.



white/birch

RIVER TWIN BED *with optional TRUNDLE*

Modern, kid-friendly style in a space-saving design

Safe & Eco-friendly

- finishes are non-toxic, water-based and free of VOC health hazards
- twin bed is made of Baltic birch plywood and eco-MDF
- trundle is made of Baltic birch plywood and eco-MDF
- security rail is made of eco-MDF

Options & Functionality

- rounded corners for added safety
- security rail can be added to either side of the bed (sold separately)
- trundle can be used with mattress (sold separately) or to store bed linens
- mattress size: twin: 99 cm W × 191 cm L -
trundle: 97 cm W × 183 cm L × 13 cm H
- additional matching items include toy store, mini library and Merlin dressers



Twin Bed



white/birch white/walnut



Trundle



Security Rail



white



Twin Bed with Trundle and Security Rail

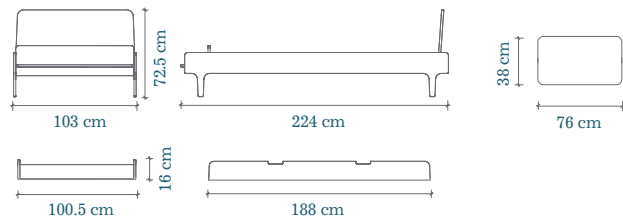

MAE'S ROOM

Snuggled under the covers or perched on the bench, Mae loves relaxing on her River bed. Most of all, she loves that the trundle below makes room for friends to join!





SPARROW TWIN BED

with optional TRUNDLE

This streamlined twin is a sleek and practical solution for your child's first bed

Safe & Eco-friendly

- finishes are non-toxic, water-based and free of VOC health hazards
- twin bed and trundle are made of solid birch and Baltic birch plywood

Options & Functionality

- trundle can be used with mattress (sold separately) or to store bed linens
- mattress size: twin: 99 cm W × 191 cm L -
trundle: 97 cm W × 183 cm L × 13 cm H
- additional matching items include toy store, mini library and Merlin dressers

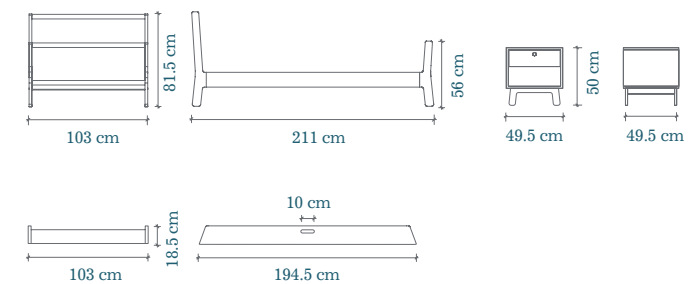

OSKANA'S ROOM

Oskana is a social butterfly, and a pillow fighter. When friends come over to join in, the trundle bed makes it easy to host the sleepovers Oskana loves.



Twin Bed



Trundle



Nightstand

PERCH BUNK BED *with optional STORAGE*

Elegant and versatile, this bunk is the perfect centerpiece for any child's room

Safe & Eco-friendly

- finishes are non-toxic, water-based and free of VOC health hazards
- made of Baltic birch plywood and eco-MDF
- shelf and console are made of eco-MDF

Options & Functionality

- upper and lower beds can stand separately, or together as a bunk
- Perch bunk includes both beds; both lower and upper beds can also be purchased individually
- compact foot print makes bunk great for small spaces
- guard rail for lower bunk (sold separately)
- top bunk recommended for children 6 years and older
- mattresses must be no more than 20.5 cm thick and 99 cm W × 190.5 cm L
- maximum load of Perch upper bed is 115 kg.
- shelf and console (sold separately) come with optional brackets and legs

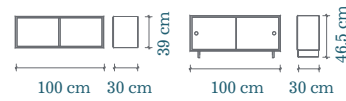
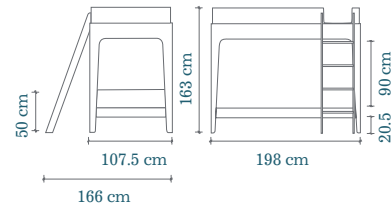

Complete bunk bed with guard rail



Twin loft bed in walnut



Twin lower bed (all white)



white/birch

white/walnut



white

Security Rail

Shelf with legs

Console with legs



MARIUS' ROOM

Marius likes to play in his bed pretending it's a fort to defend, or a ship to sail around the world. ...





GEORGIA'S ROOM

Georgia can't decide what she likes more, lounging on her loft bed or hanging out in the space below.



PERCH FULL LOFT BED

with optional STORAGE

The graceful and sleek Perch Loft leaves plenty of space underneath to play or lounge

Safe & Eco-friendly

- finishes are non-toxic, water-based and free of VOC health hazards
- loft bed is made of Baltic birch plywood and eco-MDF
- shelf and console are made of eco-MDF

Options & Functionality

- compact foot print makes loft bed great for small spaces
- loft bed recommended for children 6 years and older
- mattress must be no more than 20.3 cm thick and 137.2 cm W x 191 cm L (standard US full size)
- maximum load of Perch loft bed is 250 lbs.
- shelf and console (sold separately) come with optional brackets and legs
- ladder can be assembled to either side

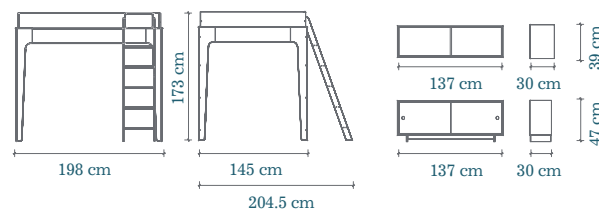

Loft bed in birch



Loft bed in walnut



white/birch

white/walnut



Shelf (without legs)



Console with legs



white



œuf
www.œufnyc.com