

œuf





## ABOUT OEUF

When we were kids, whenever our parents dropped us off somewhere like school, our grandparents' house for the weekend or even summer camp, they always gave us a hug and a kiss and told us to "be good!" as they waved goodbye.

As kids we were very literal and knew this meant...don't cut your sister's hair, don't glue yourself to the wall, don't go running off into the woods with nothing but your underwear and a toothbrush. At the time, it was mostly about good behavior.

Now as parents, we realize there is a whole other level of meaning when we kiss them goodbye and tell them to be good. We know we're really telling them to be good people. Do the right thing. Make us proud. Be the kind of people we hope to be. As Oeuf, we have the chance to elevate this notion once again and be a good company. When we say Be Good, we mean...

## BE GOOD

### **Be good designers.**

Simple, clean, intuitive products that are easy and safe to use; made with quality craftsmanship that will last from generation to generation; designed with a European sensibility that is fun and stylish, reflecting the needs and lifestyle of today's families.

### **Be good people.**

Respect the people who work with us and treat them fairly whether employees, artisans, retailers or consumers. Provide a safe and supportive working environment that allows working families to live and thrive in the United States, Europe and abroad. Honor cultural traditions, diversity and local values. Pay people living wages that enable them to live healthy and fulfilling lives and send their own children to school.

### **Be good to the planet.**

Use natural, renewable, recyclable materials that emphasize conservation and lead to environmentally sound products. Employ eco-conscious manufacturing processes that promote sustainability.

Be Good is not just something we say, it's something we mean. As parents, we want our children to inherit a world that is better than we found it. As Oeuf, we have the ability to make that happen.

**Oeuf**

# SUSTAINABILITY

**Oeuf's mission is to make practical and stylish products with minimal environmental impact.**

## Made in Europe.

Oeuf makes its furniture in Latvia, a small, densely forested country bordering the Baltic Sea. Reasons we love production in Latvia (besides the chance to visit regularly) include:

- Access to high quality, sustainably sourced local woods
- Strong local tradition of quality wood craftsmanship and hard work
- Tough EU environmental and labor regulations
- Forest Stewardship Council certified factories with advanced technology and machinery
- Recycling of wood wastes and responsible finishing-waste management
- Certified recycled cardboard packaging

## What is our furniture made from?

Oeuf furniture is made from solid birch, Baltic birch plywood and eco-MDF.

- All of the wood products used in our furniture meet Californian CARB II emission standards
- Our eco-MDF is made from recovered wood fibres and is FSC certified
- Finishes are non-toxic, water-based and free of VOC health hazards



1



2



3



4

1. Logs at the mill for processing
2. View of Latvia
- 3, 4. Our factory uses the latest technology in panel processing surface preparation and finishing





# CLASSIC COLLECTION

**Clean and contemporary, this collection leads the way in smart, modern design**

## Safe & Eco-friendly

- finishes are non-toxic, water-based and free of VOC health hazards
- crib and toddler bed are made of solid birch and eco-MDF
- dresser is made of Baltic birch plywood with eco-MDF drawer faces

## Options & Functionality

- crib converts to a true 4-sided toddler bed with conversion kit (sold separately)
- crib has 3 adjustable mattress positions
- 3 drawer dresser can be used as a changer by attaching the changing tray or pad
- 6 drawer dresser can be used as a changer by attaching the XL station
- additional matching items include toy store, mini library and changing tray
- crib and dresser have adjustable legs for uneven surfaces
- dresser has metal knobs to coordinate with legs
- mattress size: 28"W x 52"L

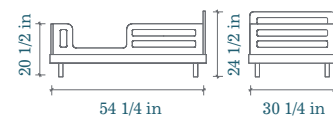
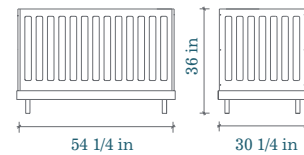

Crib



Toddler Bed



Merlin 3 drawer dresser with Classic base



Merlin 6 drawer dresser with Classic base



## MAX'S NURSERY

Max got his Classic Crib when he was one month old. He loves to play hide and seek behind the bars, or relax inside with his buddies, Ray the rat, and Silas the snake.





# SPARROW COLLECTION

**This multi-stage collection is elegant with a light and airy feel**

## Safe & Eco-friendly

- finishes are non-toxic, water-based and free of VOC health hazards
- crib is made of solid birch and Baltic birch plywood
- dresser is made of Baltic birch plywood with eco-MDF drawer faces

## Options & Functionality

- crib converts to a toddler bed with conversion kit (sold separately)
- crib has 3 adjustable mattress positions
- 3 drawer dresser can be used as a changer by attaching the changing tray or pad
- 6 drawer dresser can be used as a changer by attaching the XL station
- 4 color options to coordinate with any décor
- additional matching items include toy store, mini library and changing tray
- mattress size: 28" W × 52" L



Crib



Toddler Bed Conversion



Merlin 3 drawer dresser with Sparrow base



Merlin 6 drawer dresser with Sparrow base

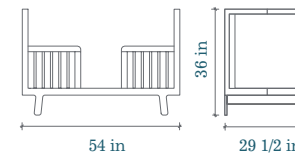
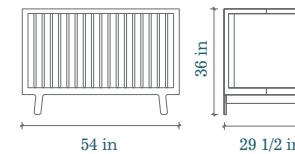

## EVE'S NURSERY

Eve is a daredevil, always trying to climb out of her crib, like her friend the monkey. So her parents decided that for her upcoming second birthday, she will get the toddler bed conversion kit.







## CHARLIE'S NURSERY

Little Charlie is a happy baby who sleeps in the Rhea crib... a lot! He shares his crib with a pigeon couple he rescued from the streets of Brooklyn, who he named Pablo and Penelope.

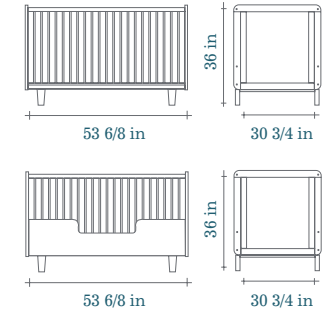

## RHEA COLLECTION

**The Rhea collection offers great value with uncompromising quality**

### *Safe & Eco-friendly*

- finishes are non-toxic, water-based and free of VOC health hazards
- crib is made of solid birch and Baltic birch plywood
- dresser is made of Baltic birch plywood with eco-MDF drawer faces

### *Options & Functionality*

- crib converts to toddler bed with conversion kit (sold separately)
- crib has 3 adjustable mattress positions
- 3 drawer dresser can be used as a changer by attaching the changing tray or pad
- 6 drawer dresser can be used as a changer by attaching the XL station
- additional matching items include toy store, mini library and changing tray
- mattress size: 28"W x 52"L



Crib



Toddler Bed Conversion



Merlin 3 drawer dresser  
with Rhea base



Merlin 6 drawer dresser  
with Rhea base





### LIZA'S NURSERY

Liza giggled when she first saw her room, when she was 3 months old. Her new crib was so sleek and playful, she knew instantly they would be best friends.



## ELEPHANT CRIB

**A fun addition to the nursery that you can assemble in 10 minutes**

### *Safe & Eco-friendly*

- sustainably produced in Europe in an FSC certified facility
- finishes are non-toxic, water-based and free of VOC health hazards
- crib is made of eco-MDF

### *Options & Functionality*

- assembling the crib takes 10 minutes
- made from 4 interlocking panels with minimal use of hardware
- crib has 3 adjustable mattress positions
- crib converts to toddler bed with conversion kit (sold separately)
- additional matching items include toy store, and mini library
- mattress size: 28"W × 52"L

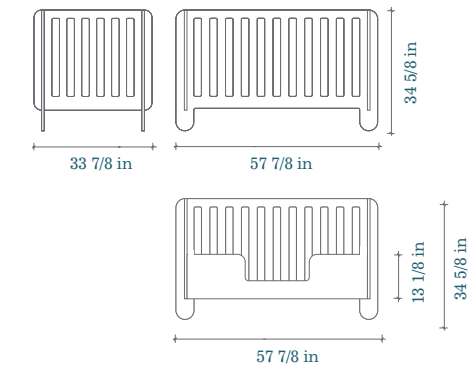

Crib



Toddler Bed



grey

white



# FAWN COLLECTION

## A convertible design to last for years to come

### Safe & Eco-friendly

- finishes are non-toxic, water-based and free of VOC health hazards
- bassinet and crib are made of Baltic birch plywood and eco-MDF
- dresser is made of Baltic birch plywood with eco-MDF drawer faces

### Options & Functionality

- bassinet converts to a crib
- crib converts to toddler bed with conversion kit (sold separately)
- crib has 3 adjustable mattress positions
- 3 drawer dresser can be used as a changer by attaching the changing tray or pad
- 6 drawer dresser can be used as a changer by attaching the XL station
- additional matching items include toy store, mini library and changing tray
- mattress size: bassinet - 16"W × 28" W  
crib & toddler bed - 28"W × 52"L (standard size crib mattress)
- bassinet mattress included

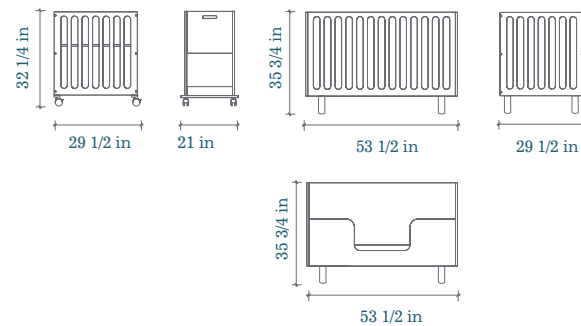

Bassinet



Crib



Conversion Kit



Merlin 3 drawer dresser with Fawn base



Merlin 6 drawer dresser with Fawn base



white/birch



## OTTO'S NURSERY

Otto has slept in the Fawn since he was born. Starting in the petite bassinet, he is now a playful toddler enjoying the converted, full sized crib.



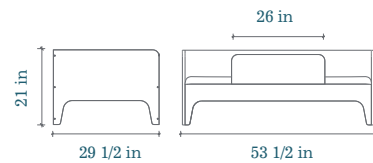

Toddler Bed with guard rail



## PERCH TODDLER BED

**Celebrate the important milestone of moving to a “big kid” bed with the Perch toddler bed**

### *Safe & Eco-friendly*

- sustainably produced in Europe in an FSC certified facility
- finishes are non-toxic, water-based and free of VOC health hazards
- made of Baltic birch plywood and Eco-MDF

### *Options & Functionality*

- easy to assemble
- toddler bed converts to a day bed by removing security rail
- comfortable sleeping for your child to age 6
- additional matching items include Perch bunk bed, Merlin dressers and mini library
- standard crib mattress size: 28”W × 52”L



### SIMON'S ROOM

Simon knows he's a big kid now, so he likes having a Perch toddler bed instead of a crib - especially since it's so much easier to get out to play with his cars!







# MERLIN DRESSER

## Designed to match all Oeuf collections

### Safe & Eco-friendly

- anti-tipping hardware included
- finishes are non-toxic, and free of VOC health hazards
- dresser is made of Baltic birch plywood with eco-MDF drawer faces

### Options & Functionality

- 3 drawer dresser can be used as a changer by attaching the changing tray or pad

- 6 drawer dresser can be used as a changer by attaching the XL station
- drawers have a 50 lbs. weight capacity
- concealed undermount roller bearing drawer slides, with soft closing and stay-close features
- coordinates with all Oeuf collections by changing its legs
- dresser with classic base has adjustable legs for uneven surfaces
- dressers have coordinating knobs and legs
- minimal assembly required
- changing pad is sold separately

### Sparrow base

### Classic base

### Rhea base

### Fawn base

### Merlin 3 drawer dresser



### Merlin 6 drawer dresser

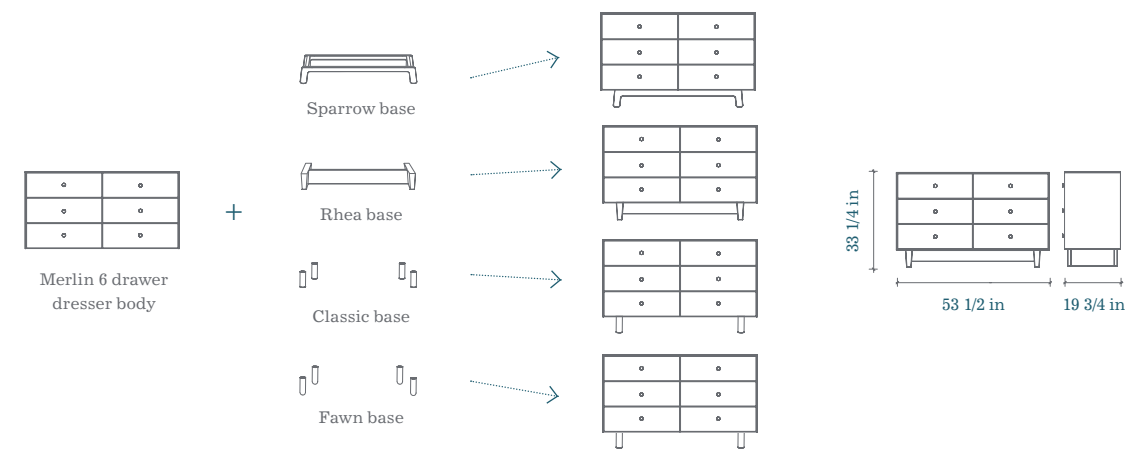
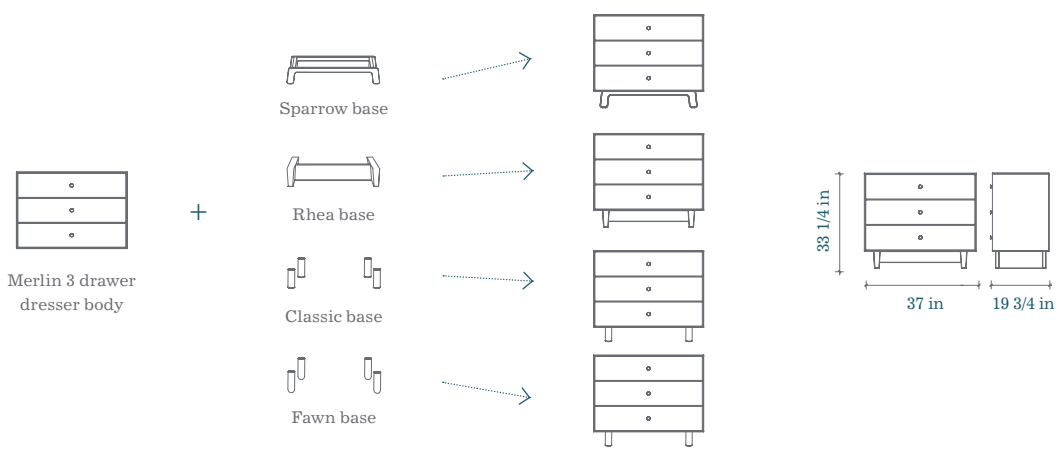





## CHANGING TRAY & XL STATION

**Practical and versatile, these changing trays can turn your dresser into a changing table, which is perfect for smaller spaces**

### Safe & Eco-friendly

- finishes are non-toxic, water-based and free of VOC health hazards
- made of solid birch and Baltic birch plywood

### Options & Functionality

Changing tray:

- attaches safely to the Merlin 3 drawer dresser
- changing pad included (16"W × 32 1/2"L × 4"H)

XL Station:

- attaches safely to Merlin 6 drawer dressers
- converts to wall-mounted shelving unit
- adjustable compartments for convenient storage
- changing pad sold separately



Changing tray on Merlin 3 drawer dresser



XL Station on Merlin 6 drawer dresser

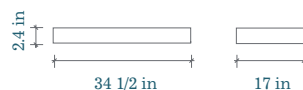

Changing tray



white grey

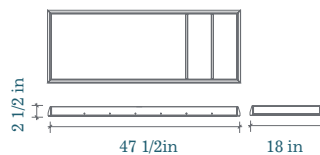

XL Station



white

## TOY STORE & MINI LIBRARY

**Stylish and accessible storage for your child's favorite items**

### Safe & Eco-friendly

- sustainably produced in Europe in an FSC certified facility
- finishes are non-toxic, water-based and free of VOC health hazards
- made of Baltic birch plywood and eco-MDF

### Options & Functionality

Toy Store:

- bins can be angled or flat
- dividers can be removed
- low overall height for easy access
- coordinates with all Oeuf collections

Mini Library:

- open and closed storage
- easy to reach height for the little ones
- small foot print makes it great for small spaces
- coordinates with all Oeuf collections

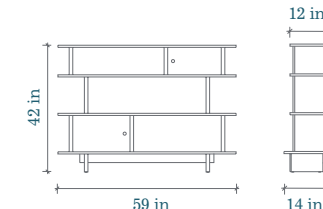
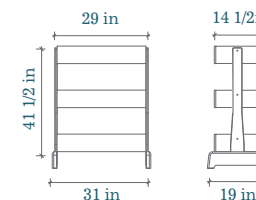

white/birch  
white/walnut

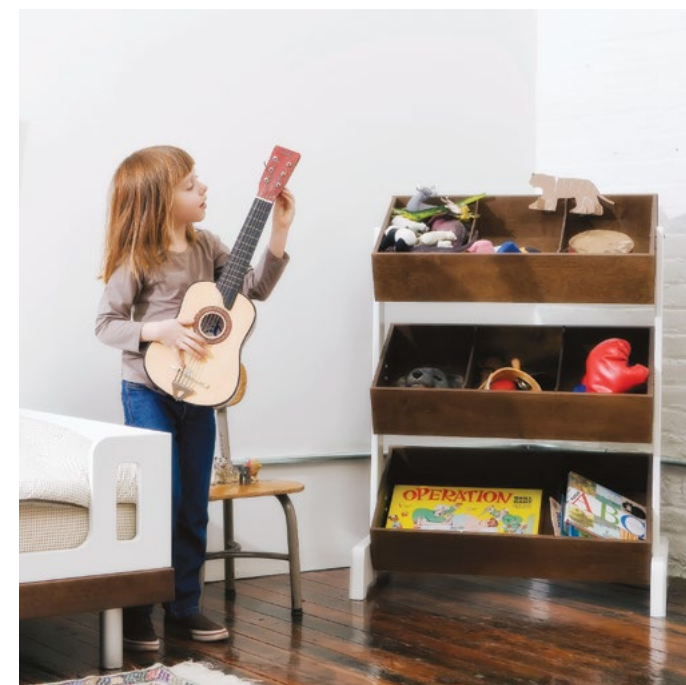





Chairs shown with Oeuf reusable stickers applied (sold separately)



### DANTE'S PLAY ROOM

Dante is an artist who has never been one to color inside the lines. The play table and whimsical animal chairs feed right into his imaginative mind, creating the perfect work space...or a good spot to just have a snack!



## PLAY TABLE & CHAIRS

### The PLAY TABLE and CHAIRS: Adding a spirit of whimsy to the home

#### Safe & Eco-friendly

- finishes are non-toxic, water-based and free of VOC health hazards
- chairs are made of bent Baltic birch plywood, table made of Baltic birch plywood and scratch resistant high pressure laminate

#### Options & Functionality

- easy to assemble
- chairs have low seat for children from age 2 to 6 (sold as a set of 2)
- easy-to-clean laminate tabletop

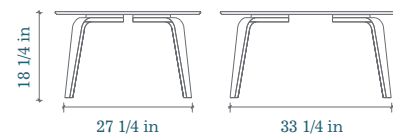
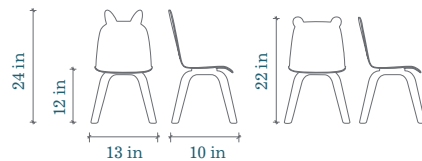





## SPARROW TWIN BED

with optional TRUNDLE & NIGHTSTAND

**This streamlined twin is a sleek and practical solution for your child's first bed**

### Safe & Eco-friendly

- finishes are non-toxic, water-based and free of VOC health hazards
- twin bed and trundle are made of solid birch and Baltic birch plywood
- nightstand is made of eco-MDF with Baltic birch plywood

### Options & Functionality

- trundle can be used with mattress (sold separately) or to store bed linens
- mattress size: twin: 39"W × 75"L - trundle: 38"W × 72"L × 5"H
- nightstand matches Sparrow twin bed and Perch bunk bed
- additional matching items include toy store, mini library and Merlin dressers

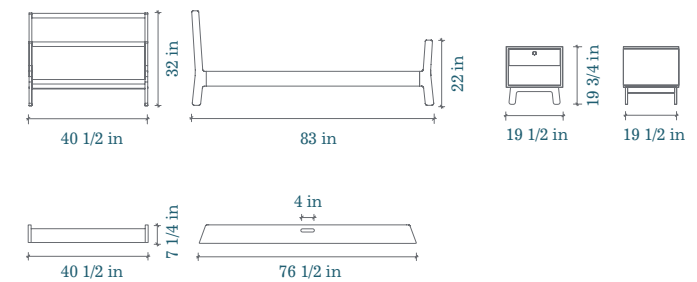

### OSKANA'S ROOM

Oskana is a social butterfly, and a pillow fighter. When friends come over to join in, the trundle bed makes it easy to host the sleepovers Oskana loves.



Twin Bed



Trundle (in birch only)



Nightstand



# RIVER TWIN BED *with optional TRUNDLE*

## Modern, kid-friendly style in a space-saving design

### Safe & Eco-friendly

- finishes are non-toxic, water-based and free of VOC health hazards
- twin bed is made of Baltic birch plywood and eco-MDF
- trundle is made of Baltic birch plywood and eco-MDF
- security rail is made of eco-MDF

### Options & Functionality

- rounded corners for added safety
- security rail can be added to either side of the bed (sold separately)
- trundle can be used with mattress (sold separately) or to store bed linens
- mattress size: twin: 39"W × 75"L - trundle: 38"W × 72"L × 5"H
- additional matching items include toy store, mini library and Merlin dressers

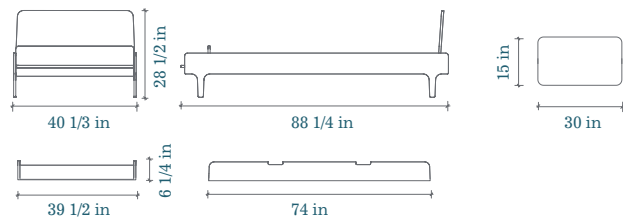

Twin Bed



white/birch white/walnut



Trundle



Security Rail



white



## MAE'S ROOM

Snuggled under the covers or perched on the bench, Mae loves relaxing on her River bed. Most of all, she loves that the trundle below makes room for friends to join!



# PERCH BUNK BED *with optional STORAGE*

**Elegant and versatile, this bunk is the perfect centerpiece for any child's room**

## Safe & Eco-friendly

- finishes are non-toxic, water-based and free of VOC health hazards
- made of Baltic birch plywood and eco-MDF
- shelf and console are made of eco-MDF

## Options & Functionality

- Perch is sold as a kit with the lower and upper bed
- separates into a loft bed and a twin for configuration flexibility
- compact foot print makes bunk great for small spaces
- guard rail for lower bunk (sold separately)
- top bunk recommended for children 6 years and older
- mattresses must be no more than 8" thick and 39"W x 75"L (standard US twin size)
- maximum load of Perch upper bed is 250 lbs.
- shelf and console (sold separately) come with optional brackets and legs

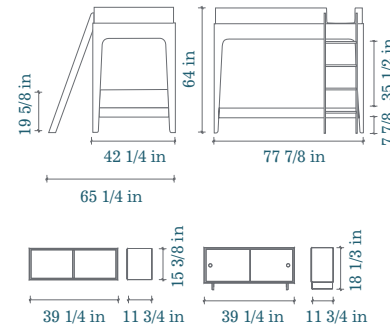

Top bunk bed and twin in birch



Top bunk bed and twin with guard rail



white/birch  
white/walnut  
Top bunk bed in walnut



## MARIUS' ROOM

Marius likes to play in his bed pretending it's a fort to defend, or a ship to sail around the world. ...







## GEORGIA'S ROOM

Georgia can't decide what she likes more, lounging on her Loft bed or hanging out in the space below.



## PERCH LOFT BED

*with optional* STORAGE

**The graceful and sleek Perch Loft leaves plenty of space underneath to play or lounge**

### *Safe & Eco-friendly*

- finishes are non-toxic, water-based and free of VOC health hazards
- loft bed is made of Baltic birch plywood and eco-MDF
- shelf and console are made of eco-MDF

### *Options & Functionality*

- compact foot print makes loft bed great for small spaces
- loft bed recommended for children 6 years and older
- mattress must be no more than 8" thick and 54"W × 75"L (standard US full size)
- maximum load of Perch loft bed is 250 lbs.
- shelf and console (sold separately) come with optional brackets and legs
- ladder can be assembled to either side

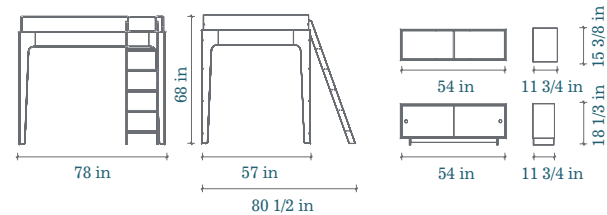

Loft bed in birch



Loft bed in walnut



white/birch

white/walnut



Shelf (without legs)



Console with legs



white





**œuf**

[www.œufnyc.com](http://www.œufnyc.com)